

Solenoid Valve

Spec. & Features

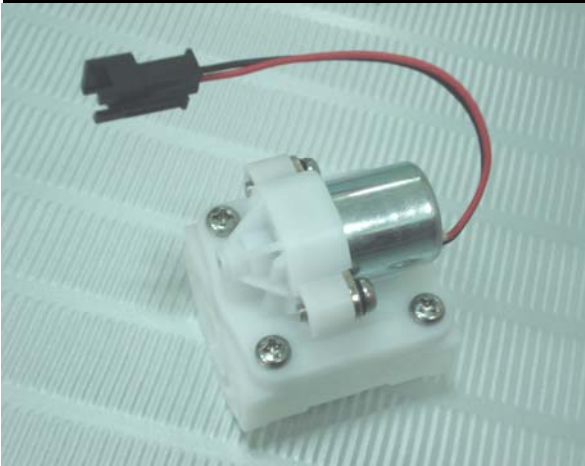

Model : SV222DC
 Power Source : DC6V Alkaline or Lithium Battery
 Voltage Range : DC6V±10%
 Current Consumption : DC500mA(Max)
 pulse (ms): on 25 ms / off 15 ms
 Power Consumption : 3W (Maximum)
 Flow Rate (1kgf/cm²) : 13L/min(Minimum)
 Water Pressure : 0.5 ~ 7.5Kgf/cm²
 Ambient Temperature Range : 4°C ~ 50°C
 Ambient Humidity Range : 90% RH
 Coil Resistance : 12Ω
 Mechanic Life : 500000 Cycles
 Pressure Stand : 35Kgf/cm² , 1 minute
 Outline Dimension : 43*40*51mm

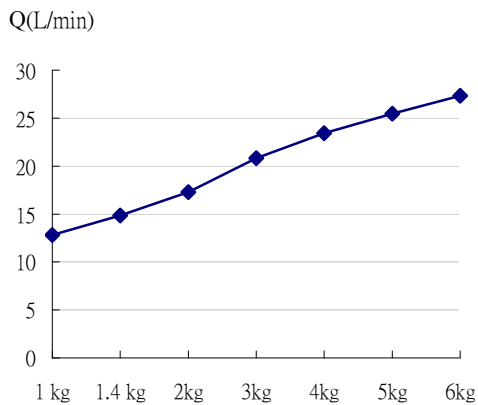

P(Kgf/cm²)

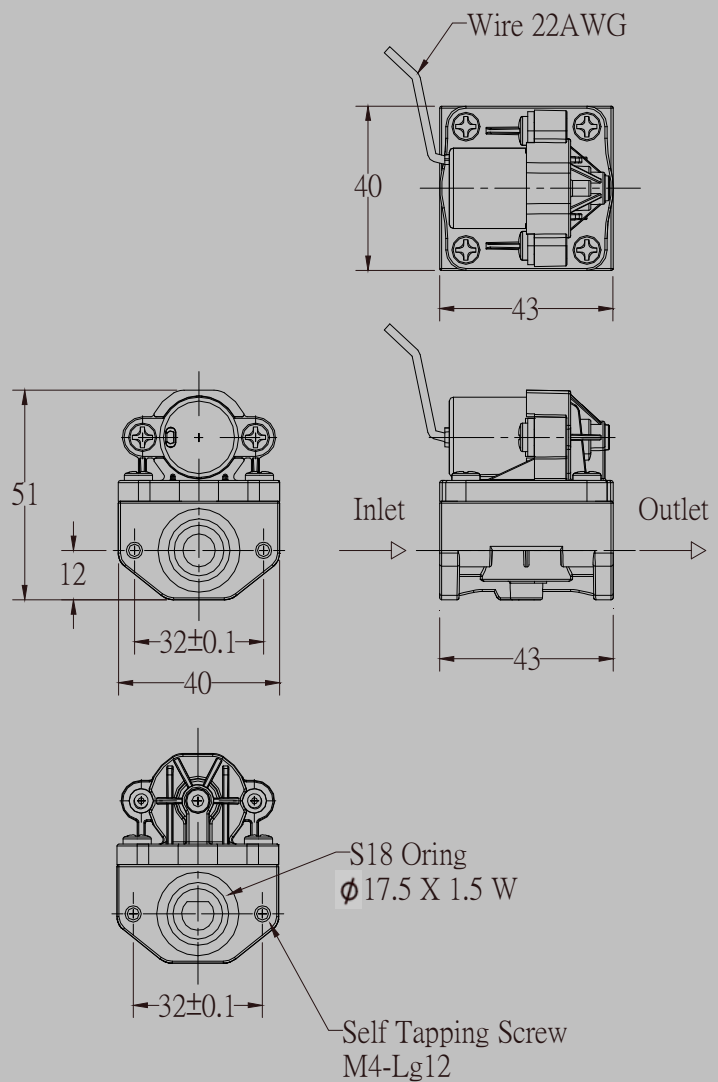

Unit : mm